

Article number: 0102061

Description: Retaining ring J44 DIN472
Spring steel

Measures

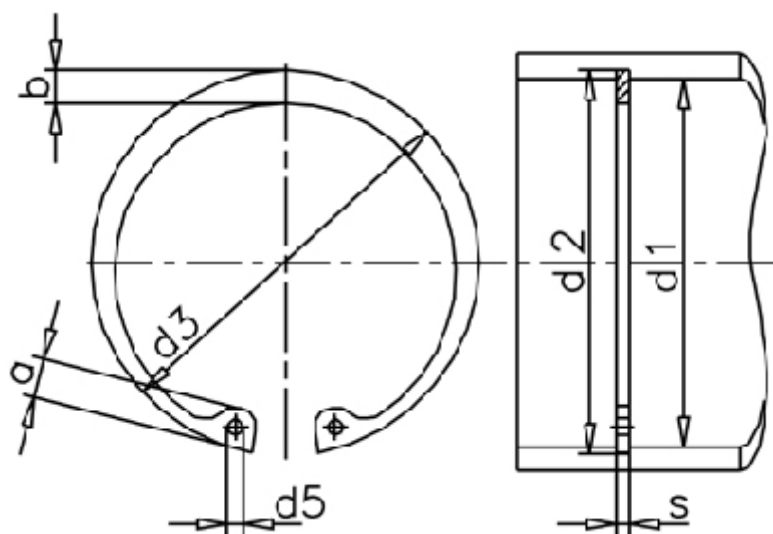

a max	= 6.0	FN kN	= 29.50	t	= 1.25
AN mm ²	= 177.0	FRg kN	= 8.3	tol	= +0,25
b	= 4.2	FR kN	= 43.3	tol	= +0,90-0,39
d1	= 44	g	= 2.0	tol	= -0.06
d2	= 46.5	K kN-mm	= 78.6	Tong	= ZGJ-3
d3	= 47.50	m min	= 1.85	Weight kg/1000	= 5.80
d5 min	= 2.5	Nominal drive	= 3.8		
Description = J 44		s	= 1.75		